

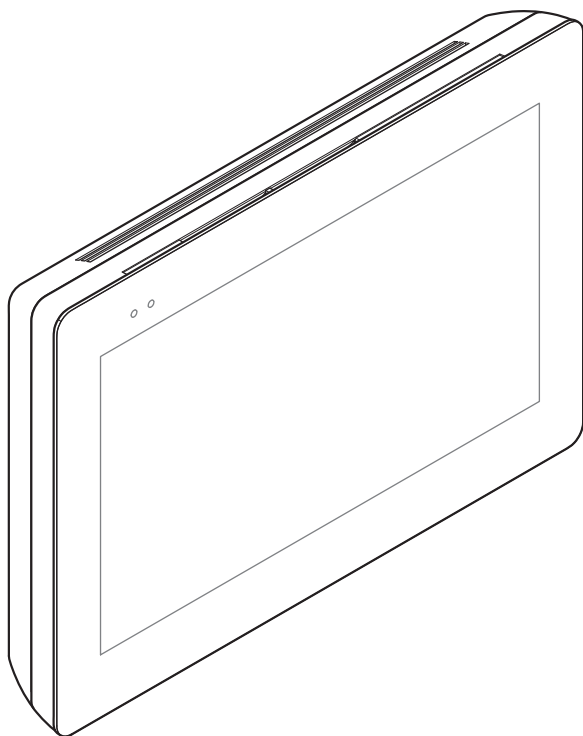

## Wifi touch-screen speaker video-intercom

FB01263-EN



**XTS 7 WH WIFI**  
**XTS 7 BK WIFI**  
**XTS 7 WH WFBF**

USER MANUAL

EN English

## GENERAL PRECAUTIONS

- Carefully read the instructions before using the device.
- The installation, programming, commissioning and maintenance of the product must only be carried out by qualified technicians, properly trained in compliance with the regulations in force, including health and safety measures and the disposal of packaging.
- Use this equipment solely for the its specifically intended purpose.
- The manufacturer declines all liability for any damage as a result of improper, incorrect or unreasonable use.

### Maintenance and precautions when using the device

- Do not expose the LCD screen to direct sunlight.
- To clean, only use soft, dry, or slightly-moistened cloth rags. Do not use any chemicals.
- Do not block the air vents.

## DESCRIPTION

Full-touch speaker video intercom for the X1 system.

### Description of parts

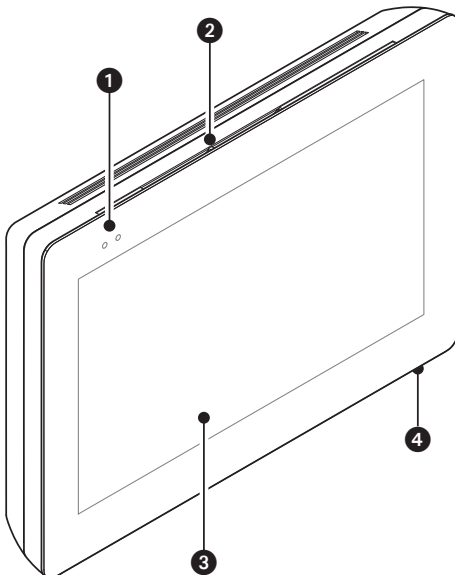

- 1 Signaling LED
- 2 Speaker
- 3 Touch screen display
- 4 Microphone.

## Commands and notifications found on the home page

 The appearance of the homepage may vary according to the system configuration or the user interface.

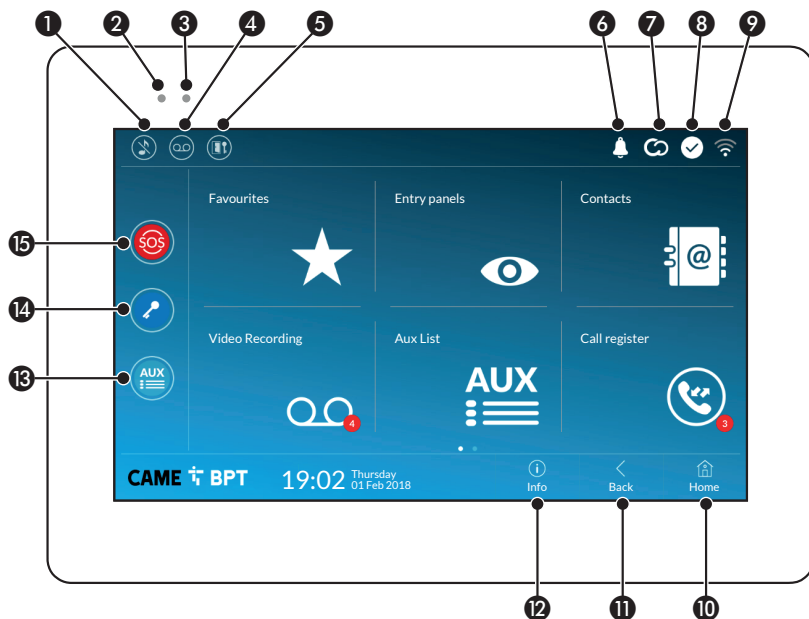

**1** Command to exclude call ringer; when the command is active, the red LED is lit.

**2** The red LED means that the device's ringer is turned off

**3** The blinking blue LED, when the screen is standing by, means that there are unseen messages or missed calls

**4** Turns the answering service off or on

**5** Turn the automatic door opener on or off

 This icon appears only if the automatic door opener function is properly set up.

**6** The blinking icon means there are unseen messages or missed calls

**7** The grey icon means that the device is enabled for connecting to CAMEConnect; the white icon means that the device is connected to CAMEConnect.

**8** The white icon means that the device is working properly and is ready to take any calls

**9** The icon means that the Wifi connection is active and strong

**10** This button appears on all screens and is for returning to the homepage

**11** This button appears on all screens and is for returning to the previous page

**12** This button appears on all screens and is for accessing the information pages

**13** This activates the preset auxiliary command

**14** Preset door opener command

**15** SOS button: pressed for at least 5 seconds, it sends a "panic" alarm signal to the default porter, showing the number of the calling extension.

 This button is featured in systems that require a concierge service.

## HOW TO USE THE DEVICE

### Answering a call



An image of the caller appears on the screen. The audio from and towards the caller is turned off.

- 1 Touch the button to answer the call and to turn on the audio communication.
- 2 Touch the button to refuse the call and to return to the homepage.

#### Options appearing on the screen during a conversation

- 3 Call duration.
- 4 Caller's ID.

#### Commands that are active during a conversation

- 5 It turns on the electric lock of the shown entry panel.
- 6 This opens the list of auxiliary commands configured for the shown entry panel; touch the name of the command that you want to send.
- 7 It is used to adjust the audio volume of the conversation in progress.
- 8 It turns off the microphone (mute function).
- 9 Touch the button to start audio/video recording the current conversation.

A red light signal blinks next to the caller's ID during the recording.

 The recording is automatically ended after 10 seconds.

- 10 It is used to access to a list of CCTV cameras that can be viewed. Select the camera you want to view; the audio and the door opener and auxiliary controls remain open to and from the calling entry panel.
- 11 Touch and drag the image on the screen (or press the > arrow) to view the listed entry panel or analog video camera (if one is installed); the current audio/video call is ended.

## Making a call

This device lets you call other indoor receivers (intercommunication), any devices connected over the Wifi network or, any entry panels.

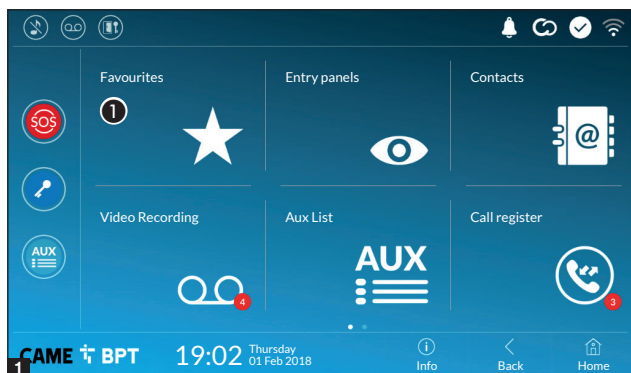

### Calling a contact on the favorites list

1 Touch the icon to access the list of favorite contacts.

2 To fill the list of favorite contacts, see the chapter called "Contacts" on page 7.



Select one of the listed contacts to initiate a call.

3 Touch the icon to view contact's details.

4 Touch the icon to remove the contact from the list of favorites.



When communication is underway, certain commands and information appear on the screen, as mentioned before in the "Answering a call" chapter on page 4.



## Turn on communication to entry panel

2 Touch the icon to access the list of entry panels.

To fill the list of entry panels, see the "Contacts" chapter on page 7.



Select the entry panel to initiate a call.

This opens the door associated to the entry panel without initiating a call.

Opens a pop-up containing a list of auxiliary commands associated to the entry panel.

Touch the icon to view contact's details.

Touch the icon to remove the contact from the list of favorites.



When communication is underway, certain commands and information appear on the screen, as mentioned before in the "Answering a call" chapter on page 4.

## Contacts







Touch the icon to access the contacts list.





The list contains all the devices that can be contacted.

### Commands associated with contacts

-  Opens the door associated to the entry panel.
-  Opens a pop-up containing a list of auxiliary commands associated to the entry panel.
-  Adds/removes the selected to and from the favorites list.
-  Adds/removes the selected to and from the entry panels list.

### Types of contact

-  Residential unit
-  Single User
-  Concierge
-  Entry panel
-  Analog video camera

Touch one of the listed items to access the window for viewing details on the selected contact and to customize his or her name.



## Unit

1 Residential unit (includes the indoor receiver and any associated apps).

2 The indoor receiver.

3 Possible users connected to the system via app, either locally or from a remote location.

Touch one of the contacts to initiate a call.

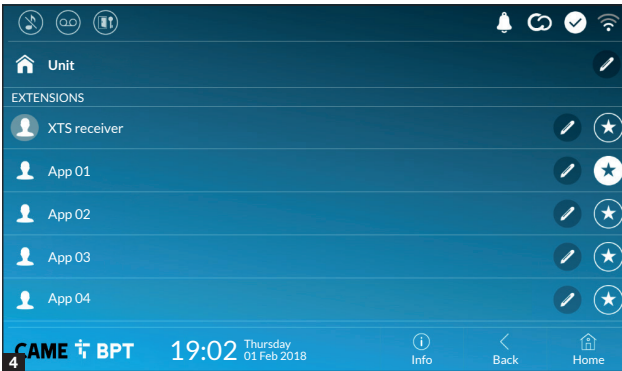

Touch the icon to edit the contact's name.

Touch the icon to add the contact to the list of favorites.

Touch the **Back** button to return to the previous screen.

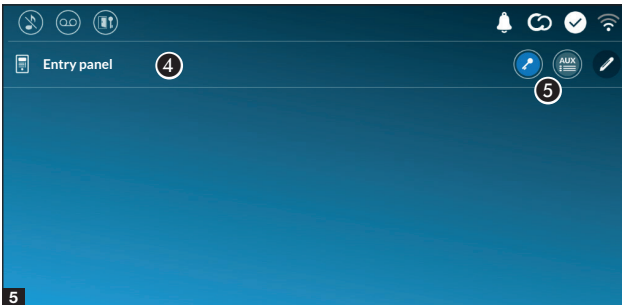

## Entry panel

4 Entry panel.

5 Commands associated to an entry panel.

Touch the contact to initiate the call.

Touch the icon to edit the contact's name.

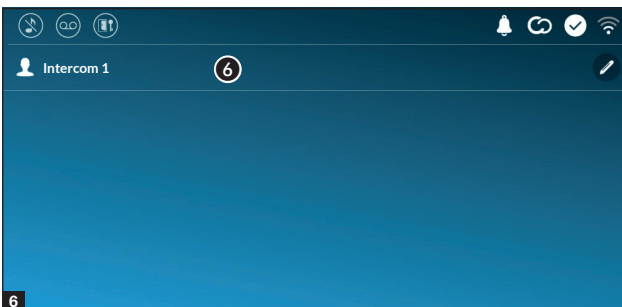

## Intercom.

6 Intercom contact.

Touch the contact to initiate the call.

Touch the icon to edit the contact's name.



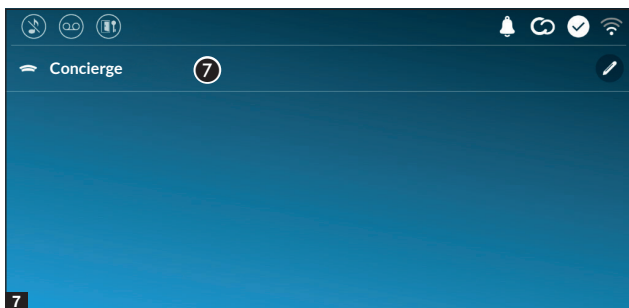

## Concierge

**7** Concierge panel, if the system features this.

Touch the contact to initiate the call.

 Touch the icon to edit the contact's name.

## Video Recording

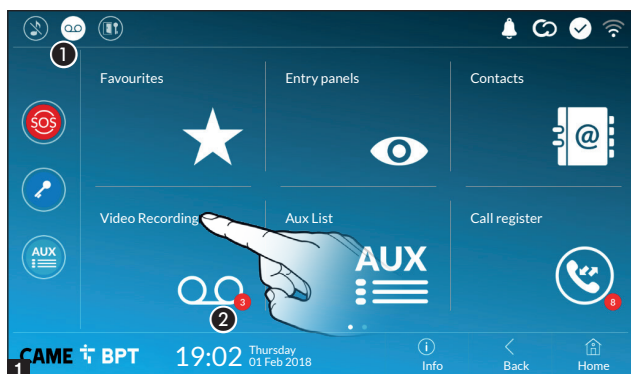

**1** Touch the icon to turn the answering service on or off.

 To properly set up the answering service, see the "Video answering service" chapter on page 15.

**2** The number with the red background is the number of unseen video messages.

When the screen standing-by, any unseen video messages, are flagged by the blinking, blue LED fitted on the frame.

Any unseen messages are highlighted.

Touch the wanted message to start its playback.

 Touch the icon to remove the message from the list.

Touch the **Back** button to return to the previous screen.



**2**

## Aux List

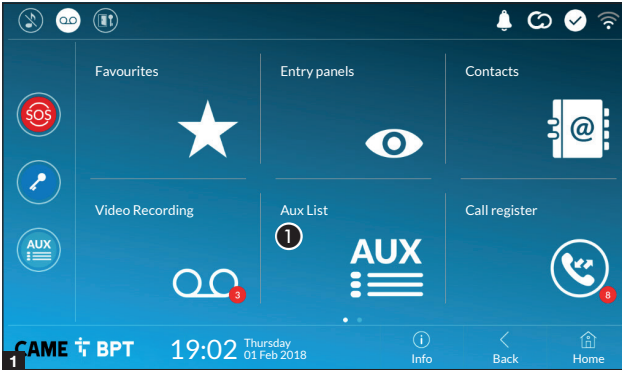

1 Touch the icon to access the list of auxiliary contacts.

The auxiliary commands (AUX) let you activate suitably programmed contacts to carry out additional commands to the classic opening of the entry door.

 To fill the list of auxiliary contacts, see the chapter called "Aux settings (auxiliary commands)" on page 13.



Touch the name of the wanted command to activate its corresponding contact.

 Touch the icon to edit the command name.

Touch the **Back** button to return to the previous screen.

## Call register

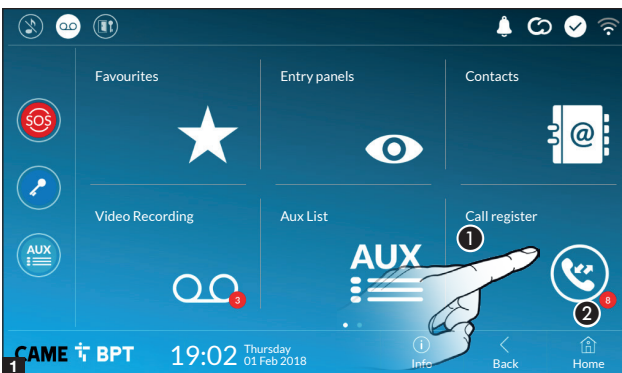

1 Touch the icon to access the call history.

2 The number with the red background is the number of missed calls.

When the screen standing-by, any missed calls are flagged by the blinking, blue LED fitted on the frame.



### Types of calls

- Incoming call.
- Outgoing call.
- Missed call.

Any missed calls are highlighted .  
Touch the line you want to call your contact.

- Touch the icon to start the saved message playback.
- Touch the icon to remove the

message from the list.

Touch the **Back** button to return to the previous screen.

### CCTV

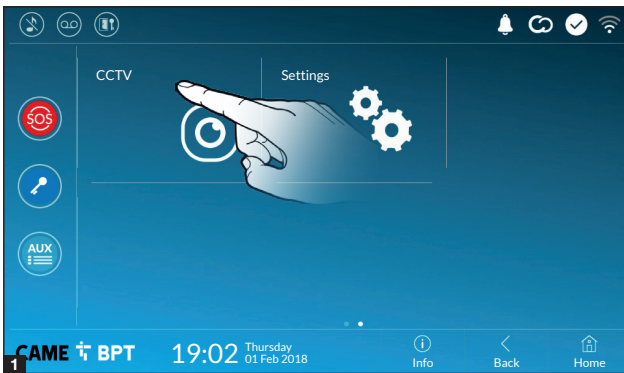

- 1** Touch the icon to access the list of available video cameras.

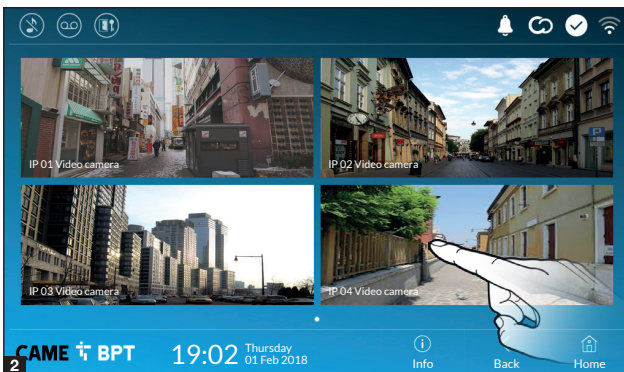

Select the IP video camera that you want to view.

## GENERAL SETTINGS

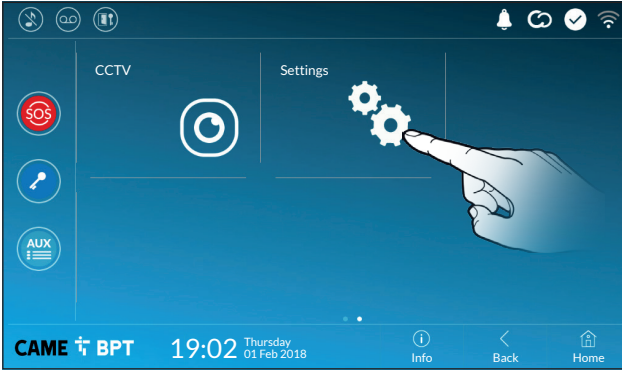

Touch the icon to return to the list of settings.

### System information

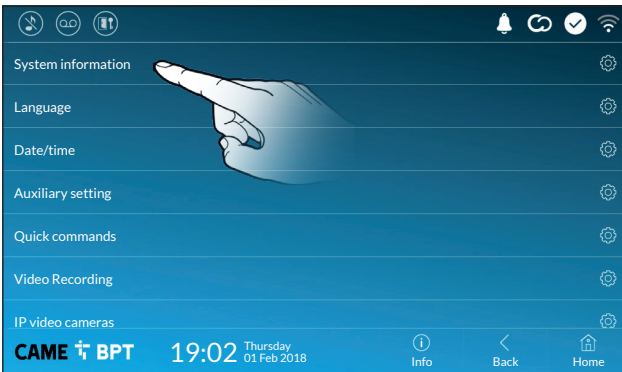

This window gives technical information that is useful for identifying the device's characteristics and the hardware and software versions.

### Language

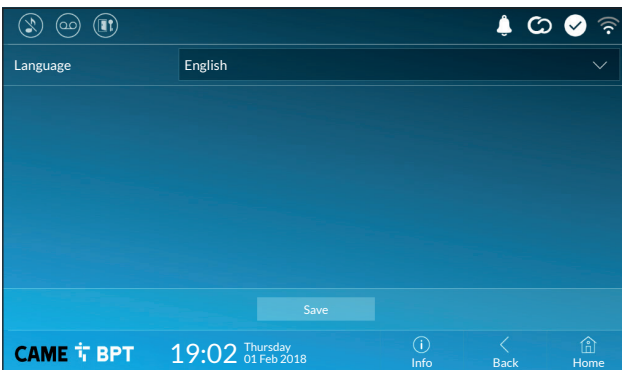

Choose the device interface language from the drop-down menu. Save the setting by touching the **Save** button.

## Date/time

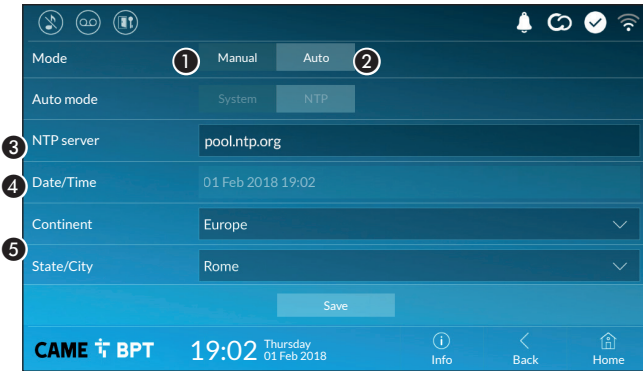

This window is for setting the date and time on the indoor receiver.

❶ The date and time are manually set by the user.

❷ Date and time are synchronized automatically.

📖 The network to which the device is connected must be able to access the internet.

Choosing mode ❷, you can specify the source of the automatic date and time.

❸ In this space provide the NTP server address through which the device will synchronize the date and time.

❹ When the manual mode is activated (❶), the pop-up window lets you manually set the current date and time.

❺ Select from the following lists, continent - state/city where the system is installed, for a correct management of the time zone and the summer time.

Save the setting by touching the **Save** button.

Touch the **Back** button to return to the list of configurable parameters.

## Aux settings (auxiliary commands)

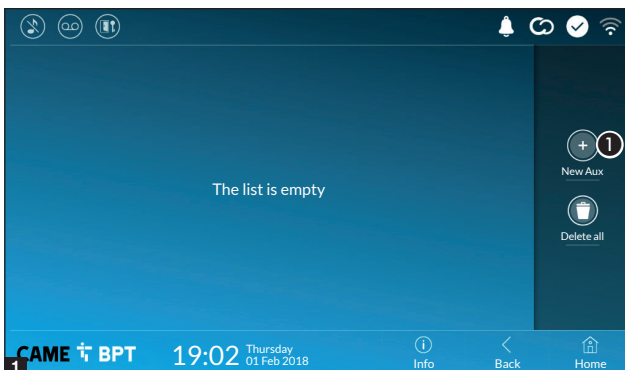

❶ Touch the button to add a new auxiliary command.

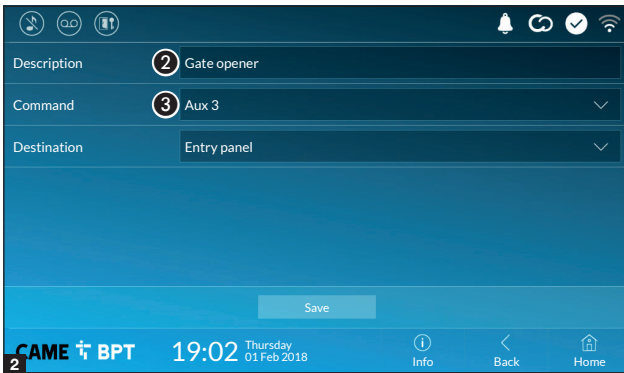

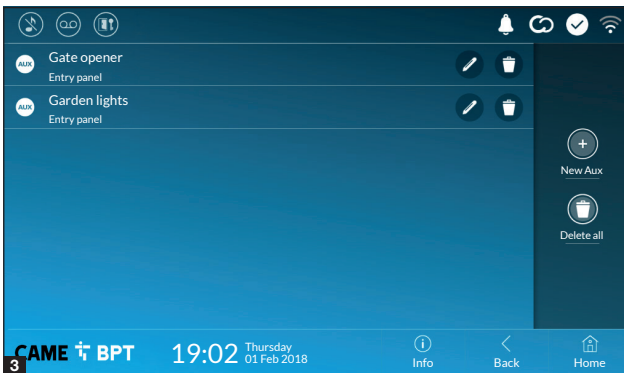

2 Touch the area to assign a name to the AUX command that you are going to add.

3 Choose the command to associate the AUX to, from the list. Save the setting by touching the **Save** button.



The auxiliary commands will fill the list.

 For editing the selected element.

 For eliminating the selected element.

Touch the **Back** button to return to the list of configurable parameters.

## Quick commands

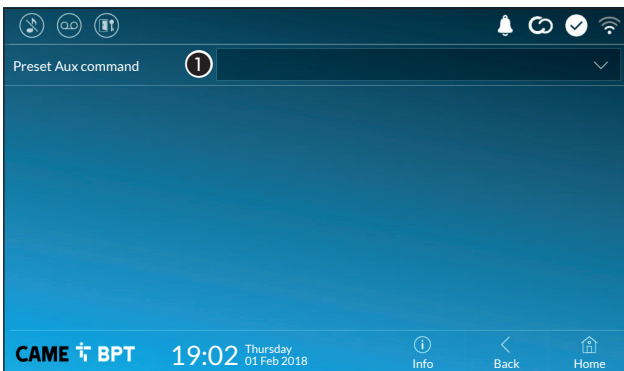

This window is for establishing which of the previously configured commands needs to be executed by pressing the Aux button on the homepage.

1 From the list select the wanted auxiliary command.

Touch the **Back** button to return to the list of configurable parameters.

## Video Recording

If the system has a video intercom entry panel installed, if the called user is not in, the device lets the caller record a video message.

The caller may be notified of this by a courtesy message, for example, "The user is not available at the moment, please leave a message after the beep".

The video message, labelled with the time and date of the call, are stored. You can view it later by consulting video voicemail.

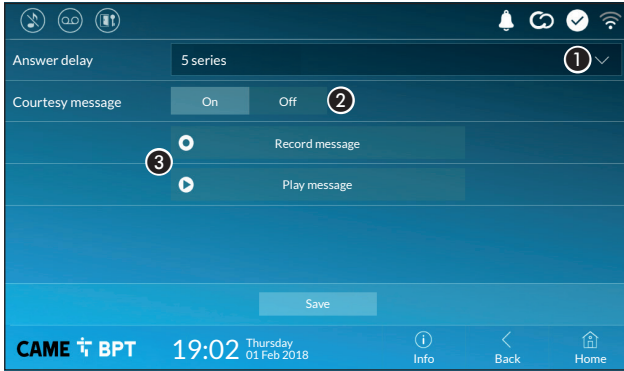

1 From the drop down menu, select the ring time - expressed in seconds - after which the automatic recording is activated.

2 Enable the courtesy message to be played back.

3 Button for recording and playing back the courtesy message.

Save the setting by touching the **Save** button.

Touch the **Back** button to return to the list of configurable parameters.

## IP video cameras

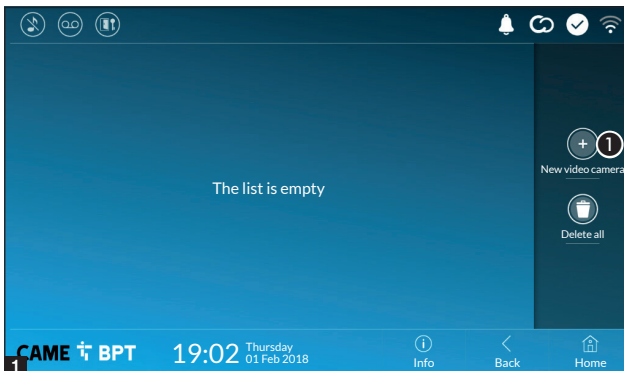

1 Touch the button to add a new IP video camera.



2 Touch the area to assign a name to the IP video camera that you are going to add.

3 Touch the area and type the URI string for connecting the video camera.

4 Touch the area and type the URI string for acquiring the static image from the video camera, needed for the preview.

The URI strings are indicated in the IP cameras manual.

Save the setting by touching the **Save** button.

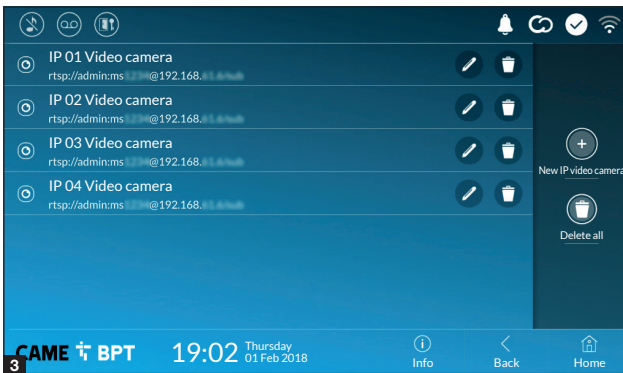

The added IP video cameras fill the list.

For editing the selected element.

For eliminating the selected element.

Touch the **Back** button to return to the list of configurable parameters.



## Backdrops

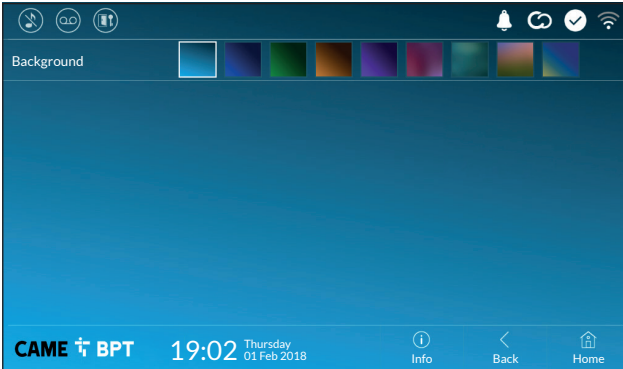

Select your preferred backdrop;; the new configuration is applied immediately.

Touch the **Back** button to return to the list of configurable parameters.

## Display

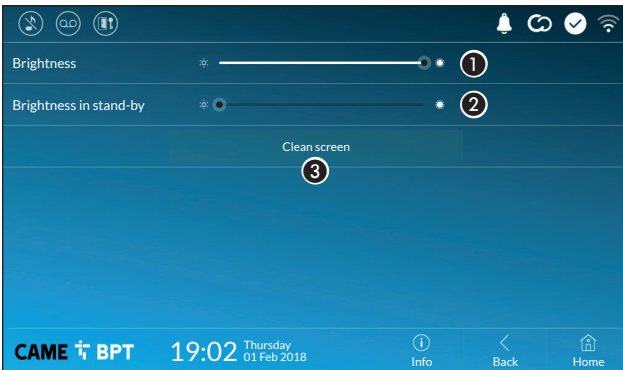

① Adjusts the brightness of the screen during use.

② Adjusts the brightness of the screen saver when the screen is in stand-by mode.

③ This makes the screen insensitive to the touch for 20 seconds, to enable cleaning over it.

Touch the **Back** button to return to the list of configurable parameters.

## Tones

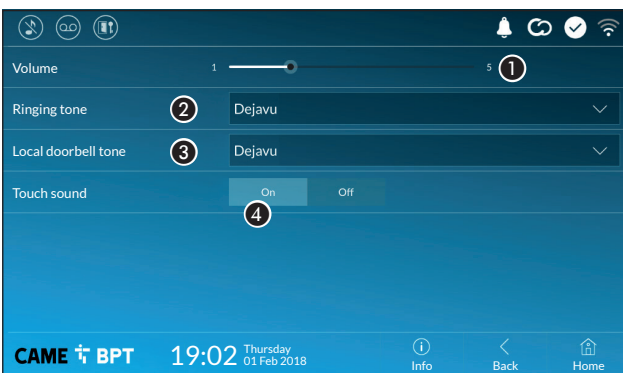

① It adjusts the general volume of the ringers for the video intercom calls.

② Choose the tone to associate to incoming calls from the drop-down menu.

③ From the drop down menu select the tone to associate to the call from the landing.

④ With this function enabled, each touch on the screen is accompanied by a sound.

Touch the **Back** button to return to the list of configurable parameters.

## Advanced settings

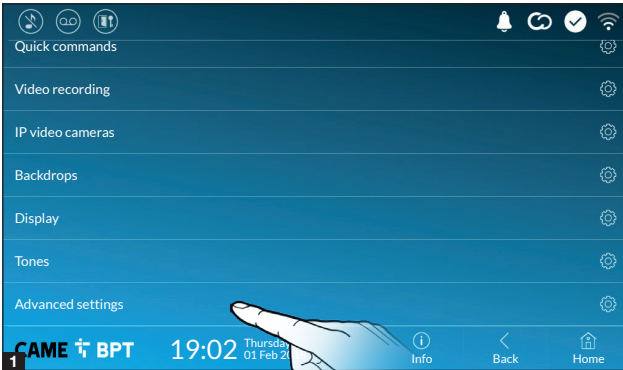

 This section requires specific know-how in operating the video-intercom system. Wrong settings may cause partial or even total malfunctions; that is why the editing of some parameters is allowed only after entering the installer password; the default password is 112233).



Accessing the list of advanced settings.

Select the first item on the list.

## Configuration X2

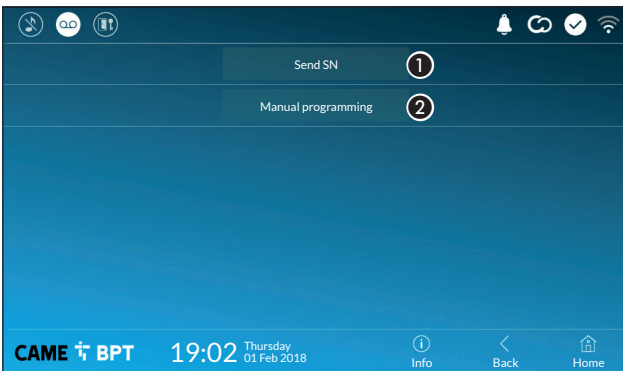

**1** This button is for sending the SN (serial number) to the Pcs/Xip software during the programming steps.

**2** This button takes you to manual programming of the device.

 The complete manual programming procedure for the call is printed in the literature that is issued with the indoor receivers.

# Network



3 This button is for enabling WiFi communication.

This icon  shows that the WiFi connection is active, enabling the network-settings sections below.

4 Lets you choose the type of address from:

## DHCP

The device's IP address is assigned by the DHCP server; if there are no special needs, this mode lets you continue with the settings without adding any additional data.

## Static

The device's IP address is manually assigned.

- 5 If you have chosen a static IP address, enter the device's IP, which must belong to the same subnet as that of the router and of the other connected devices.
- 6 If the netmask is different from the default one, provide the proper netmask.
- 7 Provide the default gateway for your network.
- 8 Enter a valid DNS address to have the CAMEConnect connection (for example, 8.8.8.8.).

 If a DHCP server is also present, the static address selected must not be among those included in the DHCP pool.

 For devices configured as a Master it is advisable to assign a static IP address. Instead if the address is generated by a DHCP server, check that the IP address is assigned on the basis of the MAC ADDRESS of the device or that the lease time is very high.

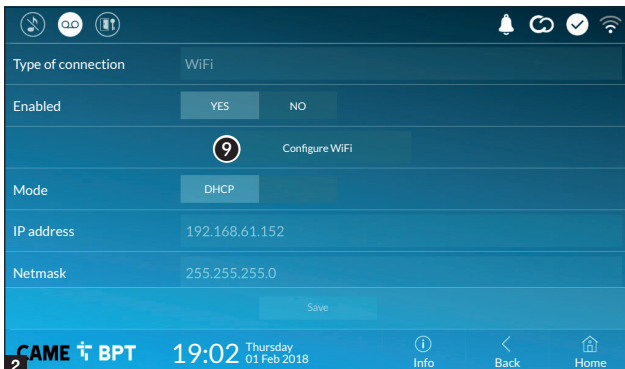

9 Once you have chosen the connection mode, the button is for selecting and setting up a Wifi network.

Every 30 seconds the device scans for available networks.



**3** The page shows the detected networks; to manually scan for networks, touch the **10** button.

Select a network to connect to. If the network is unprotected the connection will be immediate.

If the network is protected, enter the password for the WiFi network to get access.

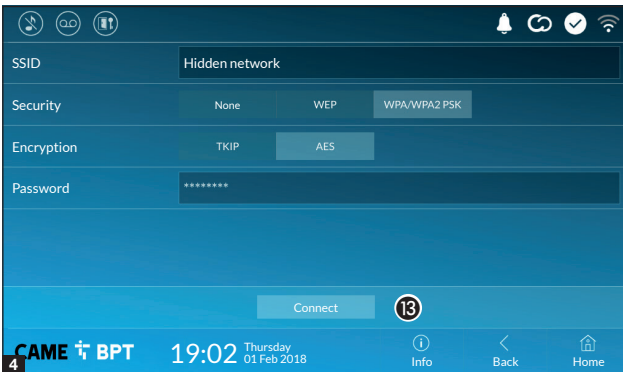

Press button **12** to save the configuration

To connect to a WiFi network with a hidden SSID, touch this button **11**.

On the page provided you can enter an SSID, that is, network name, type of security, encryption and password; when required.

To connect, touch this button **13**.

Press button **12** to save the configuration

## CAME Connect



**1** Device's univocal code.

**2** For enabling or disabling the VoIP remote control of the video-intercom call.

The factory settings require that the connection to CAME Connect be enabled.

The CAME Connect connection must be active to receive calls over the App.

**3** URL of the service for remote calls (the default one is xip01.cameconnect.net)

**4** It shows the state of the connection.

## Multimedia

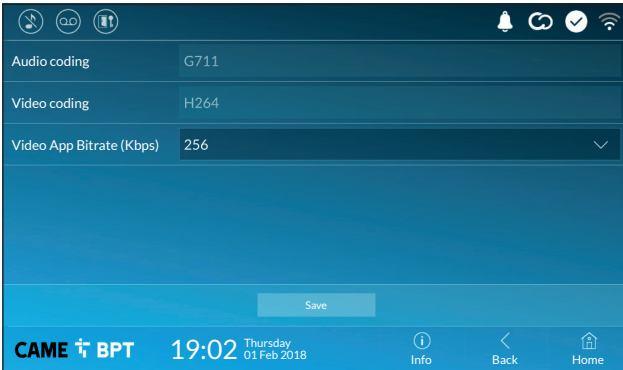

This window lets you configure the maximum BITRATE that the device can handle, while choosing among the available values.

 The greater the BITRATE values, the better the video quality, but also the greater the data bandwidth occupied in UPLINK.

If the video on the App is not fluid or deteriorated, set the lower BITRATE values.

## Credentials

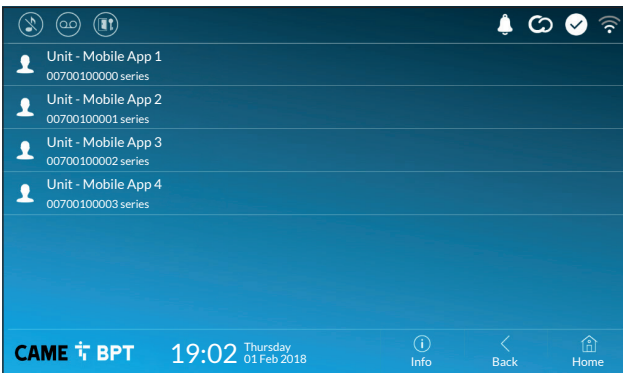

The window lets you view the credentials of the four users enabled to connect to the device via mobile devices.

Touch the user you want to access the screen that lets you assign or edit an access password.

## Automatic door opener

This function, which is especially useful for businesses, lets you automatically open the entrance once the call-button is pressed on the entry panel. The activation of this function can be programmed to schedule time slots and days of the week.

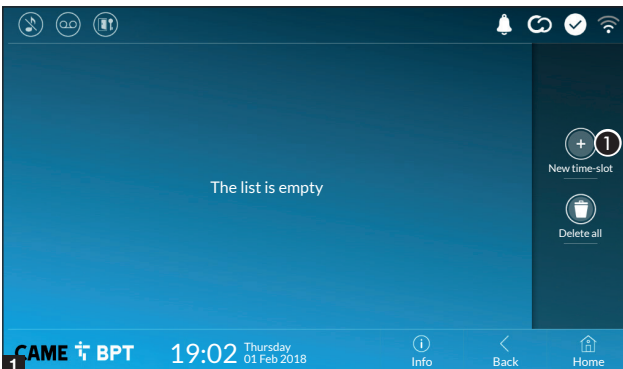

**1** Touch the button to add a new time slot.

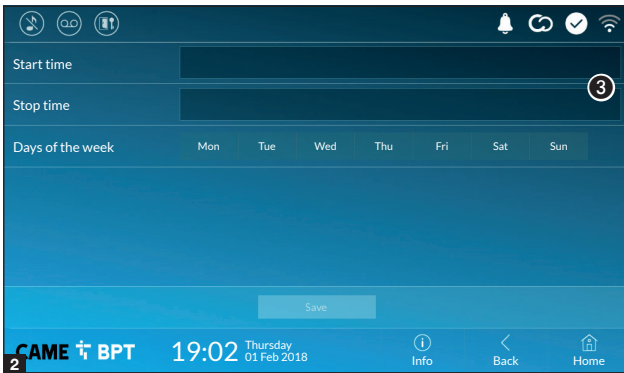

3 Touch the empty sections and in the pop-up window set the start and finish time of the time-slot for activating the function.

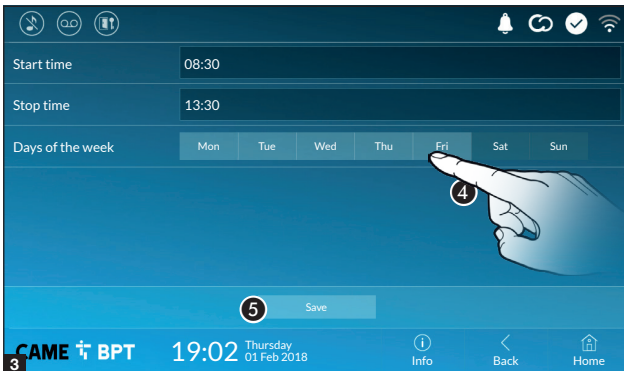



4 Touch the days of the week during which the time-slot needs to be active.

5 Touch this button to save the time-slot you have just created.

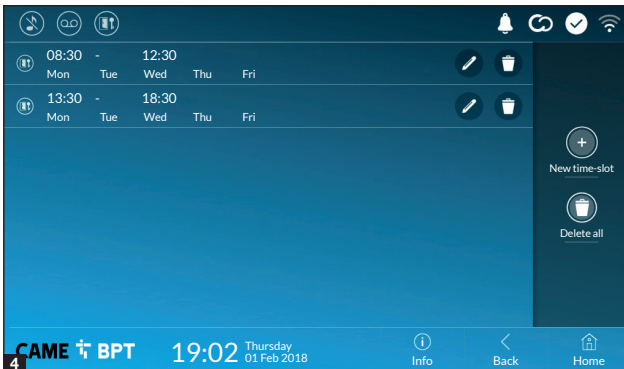
Create other new time-slots and touch the **Save** button to add them to the list.



 For editing the selected element.

 For eliminating the selected element.

Touch the **Back** button to return to the list of configurable parameters.

## Configuring the user interface

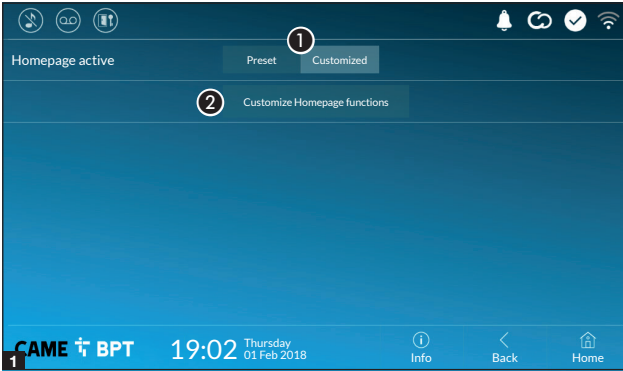

This section is for customizing the appearance of the homepage.

1 Select the type of homepage that you wish to see.

2 Touch the button to create a customized homepage.

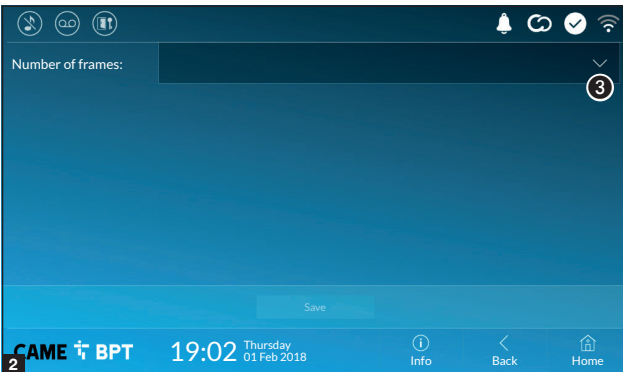

3 From the drop down menu select the total number of frames that will make up the main page.

Each page contains at most six frames; the last one is always the configuration frame.

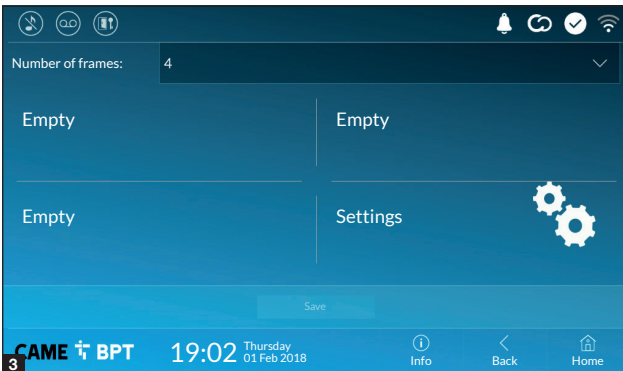

Touch each of the empty sections and use the drop-down menu to select the content that you want to assign to the section.

Save the setting by touching the **Save** button.

## Maintenance



(administrator password required; the default password is 112233).

- ① Touch the button to reboot the indoor receiver.
- ② Touch the button to reboot only the application that runs the indoor receiver.

 The factory settings require that the indoor receiver operate in "master" mode. If the system features several indoor receivers, that answer the same call within a home, only one of these must operate in "master" mode. The others must operate in "slave" mode.

- ③ Touch the button to set the indoor receiver to "slave" mode.
- ④ Touch the button to return all the local settings to the default factory settings.



## SETTINGS AVAILABLE ONLY FROM WEB PAGE

The web pages, in addition to allowing the configuration of most of the parameters that can be set by the interface of the receiver, allow provide some additional functions illustrated in this section.

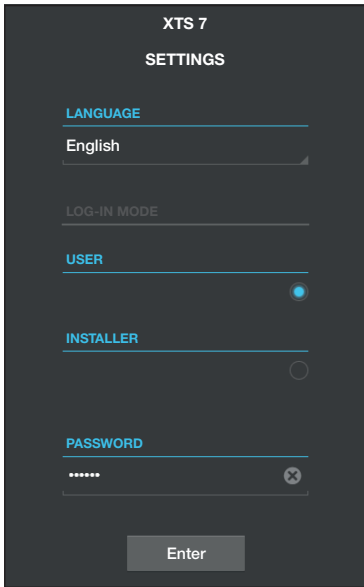

Type the address of the device in the browser address bar (Chrome, Firefox, Safari).

Select the [USER] access option and enter the password to access the configuration screens.

 When accessing with "User" credentials (default password 123456) only lets you browse the configuration pages, except the user's sections.

 There is no scroll bar on the right on the settings web pages. To scroll through the pages, press and hold down the left-hand mouse button and drag. On a smartphone or tablet, drag your finger down the screen.

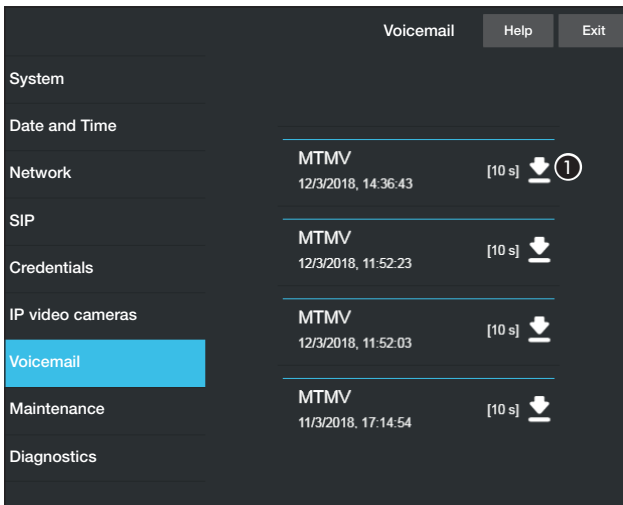

## Voicemail

With this window it is possible to view or save on your computer the voicemail messages of the device.

### View a message

Select the message and press the appropriate button to start playback.

### Save a message on your computer

 Press the button to start the download immediately.

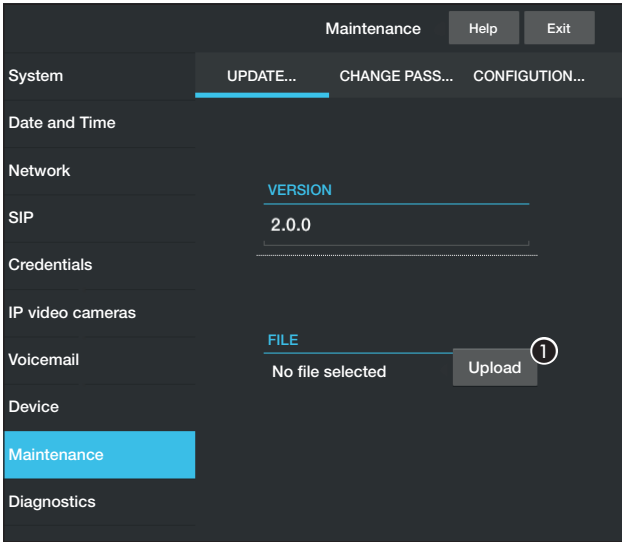

## Maintenance

### Update

This window is for updating the device's firmware, by proceeding as follows:

- 1 Press the button, select the file containing the firmware update on your computer, and start the process.

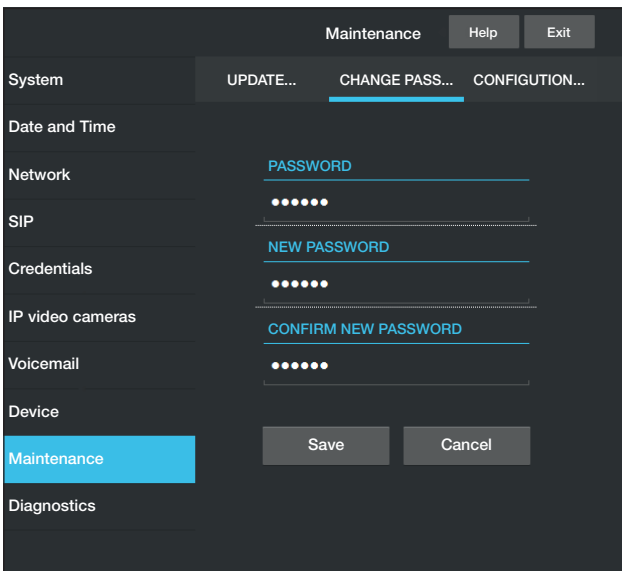

### Password change

In this window it is possible to change the password used to access.



**Pertinent Regulations.** CAME SpA, the manufacturer, declares that the products described in this manual conforms to Directive 2014/53/EU. The complete wording of the EU declaration of conformity is available at the following Internet address: [www.came.com](http://www.came.com)

**Decommissioning and disposal.** Dispose of the packaging and the device at the end of its life cycle responsibly, in compliance with the laws in force in the country where the product is used. The recyclable components are marked with a symbol and the material's ID marker.

THE DATA AND INFORMATION SHOWN IN THIS MANUAL ARE TO BE CONSIDERED AS SUBJECT TO CHANGE AT ANY TIME AND WITHOUT THE NEED FOR ANY ADVANCE WARNING. MEASUREMENTS, UNLESS OTHERWISE INDICATED, ARE IN MILLIMETRES.

**CAME** 

[CAME.COM](http://CAME.COM)

**CAME S.P.A.**

Via Martiri Della Libertà, 15  
31030 Dosson di Casier - Treviso - Italy  
tel. (+39) 0422 4940 - fax. (+39) 0422 4941